

These release notes are describing changes in LIMES 2000 since version 16.0607.806.

A number of topics with regard to measurements of automotive lighting devices are covered, the latter mainly based on GO-H goniophotometers.

With regard to the upcoming summer break we have not released this version as initially planned in August but have continued work in order to add new features for general lighting applications.

Due to their importance, the general notes regarding the installation procedure including the LMT Automation Objects are repeated again in this document.

Installation procedure

- With introduction of CQS in LIMES 2000 Revision 787, a new class of evaluation tools is implemented which requires installation of the LMT Automation Objects (LMTAO) library.
- LMTAO version 1.2, now with build number 43 or higher is required and can be downloaded from the LMT homepage. If the LMTAO library is not installed or shows a wrong version, Limes and LimesControl will not start but will display an error message indicating that LMTAO is not installed or LMTAO has a wrong build number.
- With the current release, LIMES 2000 allows transferring data from the table menu into an interactive 3D-Window, which is based on the public domain software “Gnuplot”. Currently, one-dimensional arrays like intensity and correlated color temperature can be displayed in space. In order to take advantage of the feature, the 32-bit version of Gnuplot revision 5 needs to be installed. Interfacing to 64-bit versions may be possible in future.



Left-right offset via ScanTest – GO-H applications (Automotive) only

The “ScanTest” utility in LimesControl is used to determine the offset angle between line scans originating from left or right. Ideally, both graphs should be identical but due to transit times through various amplification and filtering stages there will be always an offset which needs to be corrected. In the screenshot below a horizontal offset compensation is illustrated by fitting both red and green curve on top of each other.

ScanTest has been upgraded considerably in order to allow Limes 2000 addressing the measurement of modulated signals with a high degree of hardware flexibility.

The Scantest window now offers differentiation based on a wider range of time constants realized in the amplifiers of LMT’s photometer heads and units. This in turn allows the user choosing always the fastest possible scanning speed for a given DUT and photometer.

However, taking advantage of the increased flexibility requires more knowledge regarding the degree of light source modulation within the DUT. LMT always recommends doing cross checks to assure that scanning data coincide with point measurements. Combination of fast scanning with large time constants always bears the risk that strong gradients in the luminous intensity distribution may be slurred.

In the case of doubt, caution is advised by using a lower scanning speed.

The left-right adjustment works best if at least one cut-off, for instance from a fog lamp, is available. In the example below a highly collimated spot with a width of $\pm 1^\circ$ was used.

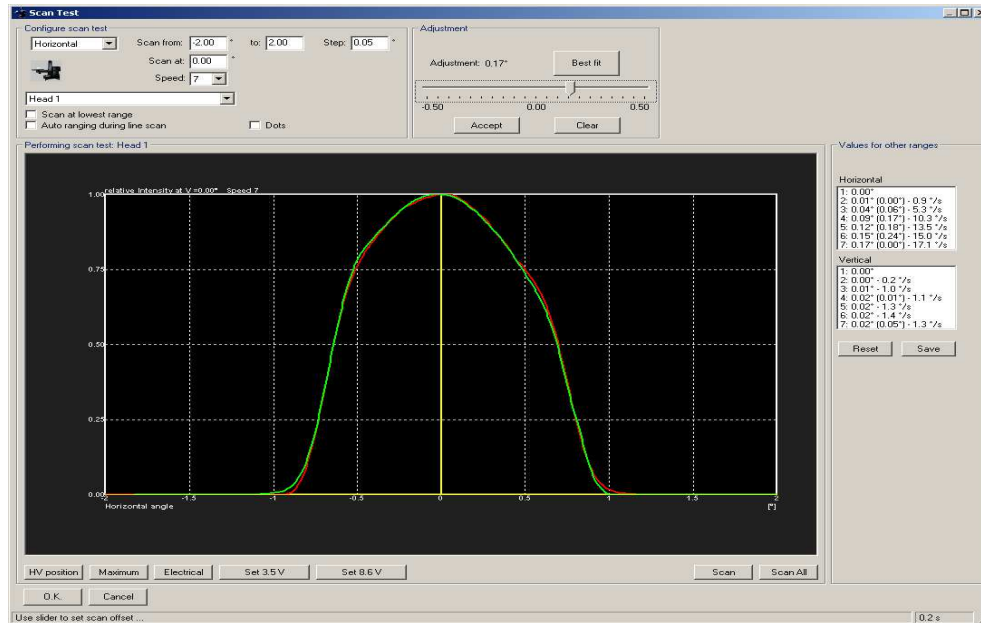

The most important points are:

- LMT's AMR devices (**A**daptive **M**odulation **R**esponse) now appear as two different logical devices, e.g. with fast and slow mode. Formerly, ScanTest allowed setting a single left-right offset compensation per photometer unit only since time constants of all heads were assumed to be very similar. Usually, speed 4-7 was assigned to fast mode (or standard photometers), while speed 2-3 has been used in slow mode (or for PWM heads).

In the meantime, each AMR head can be compensated for all speeds in both fast and slow mode for vertical and horizontal rotations. Since integration times of the most sensitive range are slightly higher than the other ranges, two different settings for lowest and upper ranges will be evaluated.

This means that especially for intermediate scanning velocities the user has now more flexibility in optimizing the measurement. Depending on modulation depth a pulse width modulated DUT may be measured in slow mode with speeds up to 5 while non-modulated signals which exhibit strong gradients may be measured in fast mode with very low rotational velocities.

- Besides including LMT's AMR systems into the ScanTest routine, all types of the S 1000 system photometer family (standard, PWM and IR) have been implemented in such a manner that each head can be corrected indi-

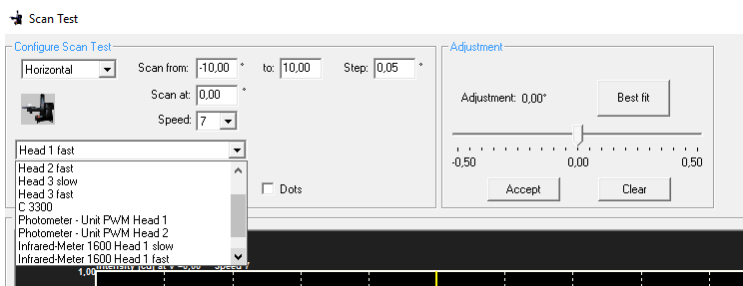

vidually in combination with the connected photometer unit.

- IR AMR heads for measuring near-infrared radiation are handled similar to standard AMR heads. See chapter below on IR measurements for more details.
- The fast scanning colorimeter C3300 is treated like a system photometer and can be similarly adjusted for lowest range and upper ranges.
- Several bugs were fixed within the “scan all” command. In order to give the user time to control functionality properly, the diagram will show the original measurement for 1 second before the “best fit” is presented. The message "scan all measurement finished" is displayed at the end. “Scan all” will only perform if at least one power setting is defined by the user.
- Ramping between different power settings is done by positioning the goniometer at (0/0) of the respective photometer head. Information is displayed to inform the user which parameter is changed (voltage or current) and successively the photometer unit will select the correct range. During all operations the selected ramp mode for the DUT is applied.
- The scan offsets determined for an individual head can be stored via the button “save” into the *.ini file before the user switches to the next head.
- In case the angular range for a scan with and without offset correction does not overlap sufficiently to obtain a best fit result, an error message will be shown instead. Therefore, the user has to increase the angular interval manually. To prevent the “Scan all” command from failure a checkbox for "Scan range enhancement" is available which automatically enhances the scan range within horizontal scans with high speed settings in slow mode.

IR measurements

- The S1000 IR with AMR heads has been fully implemented. A former bug which caused changing the calibration of the main photometer unit between different calibrations (e.g. cd and lux, and vice versa) was fixed.
- Instead of two calibrations (lx, cd) there will be only one unit available for the S1000 IR or S1600 IR unit. Measurements with an IR meter now do not display the photo current in “A” anymore. Instead, the “IR-unit” has been fixed and will be from now on always mW/sr in order to allow LIMES 2000 calculate radiative IR power correctly.
- The calibration factor can be deduced from the certificate in case absolute readings are required. Usually, LMT’s IR heads are calibrated in W/m^2 , but of course based on the distance of the head this can be immediately converted into mW/sr. Accordingly, zonal flux data from IR measurements now carry the unit mW.

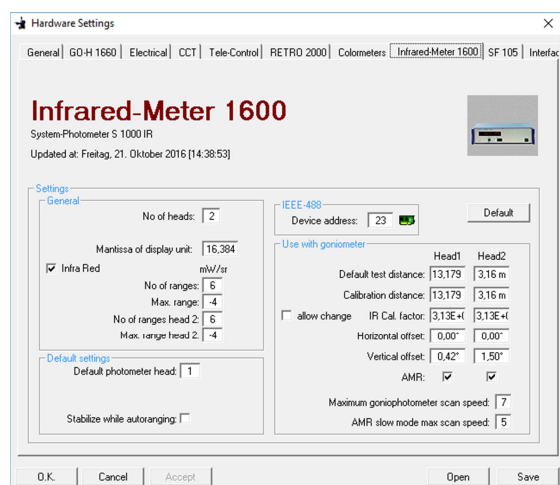

Power supplies and related topics

- In systems without dedicated multimeter sometimes the assignment of power supplies and their measurement properties was not correctly linked. The bug was fixed.
- Wrong occurrence of a “Voltage is not active” message for the last power supply in the list was eliminated.
- A work-around for unintended switching-off the SE AS 1000 AC power source after a measurement has been implemented.
- The Chroma 62012P power supply was implemented and can be within the menu.
- Ranging of Yokogawa power meters could lead to unrealistic high values which are now suppressed. Instead, power is read again until the measuring range has been stabilized.
- Changing of parameters in the stabilization window during measurement is no longer possible but can only be done if stabilization is stopped (and re-started again).

Multiplexer functionality

- Formerly, channel 1 of the multiplexer was unintentionally activated after saving and re-opening test data. The bug was fixed and multiplexer settings (e.g. channel selection) are saved accurately within the program and test data.
- The automatic lamp to multiplexer channel assignment did not work properly for some configurations. Therefore, it was deactivated and the user has to manually assign the lamps used in a measurement to the available power supplies.
- Once in a while the displayed power supply mapping does not match with the corresponding information in the configuration file. The user will now get a message if he clicks on the tab connection. In case new settings shall be saved the user is guided how to save the displayed setting correctly into the configuration file.

Data export

- The export functionality for the aiming report was added. Results can be saved in csv format to do further data processing using additional software.
- Data recorded in blinking mode can now directly be saved from the graphics window into csv format, for instance to evaluate ramp-up of sequential light source activation of turn indicators or determine rise time in flash-to-pass applications.

General lighting applications (GO-DS, GO-R and GO-V)

- Since revision 619 the intensity table by mistake displayed illuminance [lx] instead of showing [cd/klm]. The bug was fixed.
- The command *set relay* is sometimes used to switch between sensors, for instance to move the spectroradiometer into or out of the measurement axis. Unintentionally, in some configurations the settings were not saved immediately, but only during a repeated attempt. From now on exit from the *set relay* menu is only possible via *accept* or *cancel*.
- The checkbox for activating *Correct photometrical values for nominal flux* acted differently for displayed and printed values. The bug was fixed.
- Originally, the algorithm for calculating the table “zonal flux” did not consider whether *Correct photometrical values for nominal luminous flux* was activated, but calculated numbers based on measured nominal flux.
This has been changed – the zonal flux algorithm now respects the correction option.
- In the past raw data were lost when applying symmetrification. This has been changed in order to always preserve raw measurement data. Instead, only the symmetry and correction settings are saved and data are re-calculated from the original data in case the measurement file is opened again.
Consequently, this is done as well before performing an output via select protocols.
- A change of range in GO-DS integration measurements could lead to negative contributions within the zonal flux table. Although such a situation is usually avoided the bug was fixed.
- Within the zonal flux table the quantities I_{\min} , I_{mean} and I_{\max} carry different units which has been corrected. It is cd/klm only in general lighting applications in case the lamp flux is given. In all other situations (e.g. no lamp flux given) or in automotive lighting applications the unit will be shown as cd.

- Road lighting lantern classification acc. CIE No 34-1977 has been implemented within the luminaire data protocol.

Throw, spread and specific luminaire index (SLI) including the classification can be added to the luminaire data. The option is activated in the protocol section of *Edit Program* via the *Options* tab.

SLI is calculated in plane C180 in case the maximum value is found within $90^\circ \leq C \leq 270^\circ$. Otherwise C0 will be used for SLI calculation.

Entering the information for A76 within the test data is

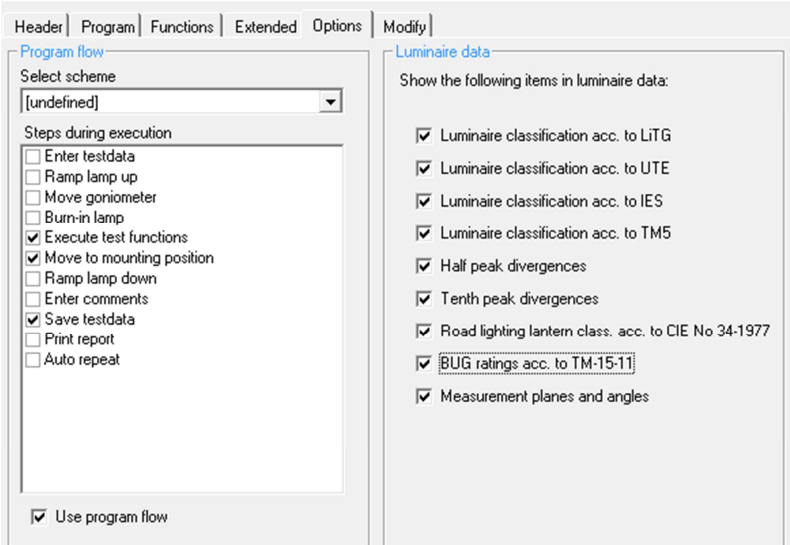

The screenshot shows the 'Options' tab in the software interface, divided into two main sections: 'Program flow' and 'Luminaire data'.

Program flow:

- Select scheme: [undefined]
- Steps during execution:
 - Enter testdata
 - Ramp lamp up
 - Move goniometer
 - Burn-in lamp
 - Execute test functions
 - Move to mounting position
 - Ramp lamp down
 - Enter comments
 - Save testdata
 - Print report
 - Auto repeat
- Use program flow

Luminaire data:

Show the following items in luminaire data:

- Luminaire classification acc. to LITG
- Luminaire classification acc. to UTE
- Luminaire classification acc. to IES
- Luminaire classification acc. to TM5
- Half peak divergences
- Tenth peak divergences
- Road lighting lantern class. acc. to CIE No 34-1977
- BUG ratings acc. to TM-15-11
- Measurement planes and angles

mandatory – otherwise calculation of SLI is not possible.

The dialog for setting up the luminaire data protocol has been moved to the corresponding table view and is activated via the *Configure* button. Formerly, this dialog was available within the table test report.

- Backlight, Uplight, and Glare (BUG) ratings according to IES TM 15-11 (see right figure) have been implemented and can be added to the luminaire data section. Implementation was done in such a way, that notation of the CIE C, γ -System is applicable.

In order to generate complete ratings at least $0^\circ \leq \gamma \leq 90^\circ$ have to be measured if the luminaire is assumed to have no uplight contribution. In case the luminous intensity at 90° is not zero, integration for the next zonal flux element is performed and an estimated value for UL will be calculated. Due to digitization and rounding effects values less than 0.1 lm are considered to be zero which leads to a U rating of zero.

In order to get a complete rating, the distribution has to be measured within $0^\circ \leq \gamma \leq 180^\circ$. U ratings are very sensitive to stray light due to the low limit of zero. Therefore, for correct ratings stray light must be avoided in any case.

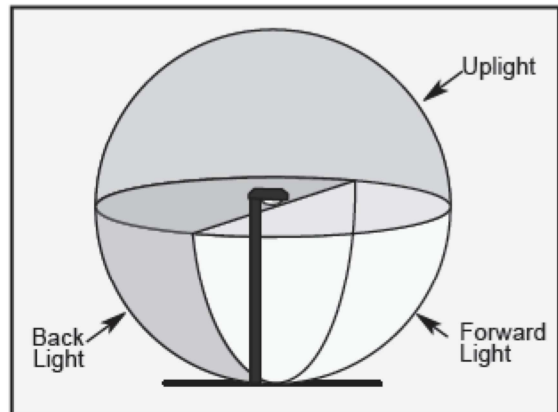

Spectroradiometric evaluation

- The report table for evaluation of radiometric properties has been re-formatted to assure that the final line containing the integrated radiometric power will be always displayed in the printout.
- The algorithm calculating average chromaticity values x and y out of a color scan did not work properly for GO-H systems in case negative angular values occurred. The bug was fixed.

Interactive 3D visualization of C, γ data

Interactive 3D visualization of one-dimensional data versus angle (e.g. illuminance, luminous intensity, correlated color temperature, spectral radiometric power, etc.) has been implemented based on the public domain software *Gnuplot 3D*. As a starting point, the feature is for the time being available for C, γ measurements only.

LIMES 2000 users interested in using this option need to install the 32-bit version of Gnuplot revision 5. It is available on various download locations, for instance at

<https://sourceforge.net/projects/gnuplot/files/gnuplot/>

or on the LMT homepage.

Interfacing to 64-bit versions has not been implemented yet.

The feature is offered within the table menu via the *Export to 3D* button and if activated, Gnuplot is launched based on data transferred from LIMES 2000 into the interactive window application. Using the mouse or any other pointing device the displayed data can be freely rotated in space for detailed analysis of the specific distribution.

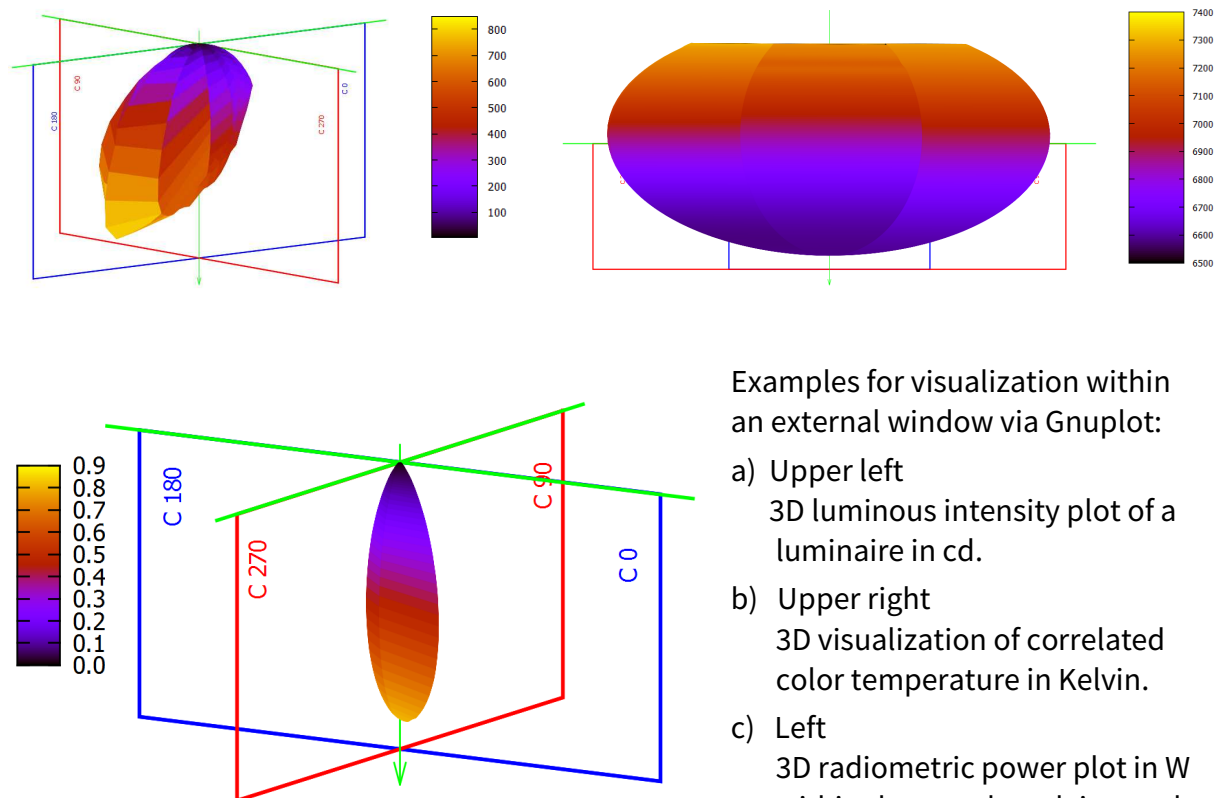

Examples for visualization within an external window via Gnuplot:

- Upper left
3D luminous intensity plot of a luminaire in cd.
- Upper right
3D visualization of correlated color temperature in Kelvin.
- Left
3D radiometric power plot in W within the wavelength interval from 580-620 nm.

A standard view is implemented by LMT, but customization of visualization parameters via Gnuplot is possible. However, this is left to the individual user. The pictures above illustrate a few examples as outlined in the figure caption.

Miscellaneous

- If the luminance meter L100X is (accidentally) chosen as measuring device within the goniometer control window, now the CCT does not automatically move to the offset position given for the L100X. Instead, this needs to be activated on purpose.
- Henceforth, within execution of programs with different S1000 photometer units automatically the correct device is selected. Formerly, it had to be activated manually upfront to the measurement.

- The corresponding S1000 control frame created by LimesControl was changed in such a way that the head number is now visible. In case of an AMR device the mode indicator “s” for slows and “f” for fast will be displayed, too. In the example shown in the LimesControl window to the right the IR meter indicates head 1 in fast mode (If).
- If available, *Edit program* now allows choosing from multiple S1000 devices and *edit data* offers selecting from all heads which are connected.
- The angular range for retro-reflection measurements using an automated Epsilon axis positioning has been increased from $-90^\circ \leq \epsilon \leq +90^\circ$ towards $0^\circ \leq \epsilon \leq 360^\circ$. Proper error handling was added in case the user is choosing angles outside this range.

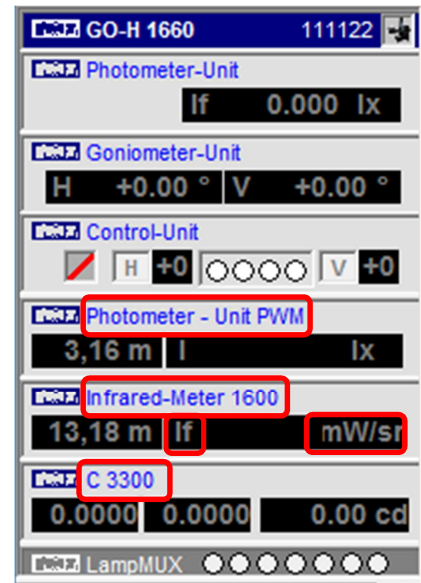

In addition, from now on the label for the observation angle will be displayed in retro-reflection point measurements.

- Sometimes the wrong language was used in the *Evaluation >Tables* menu because the regional language localization worked properly only after the second call. The bug was fixed.
- Several text forms were enlarged to display translated text with increased space requirements correctly.
- Switching the active photometer head with the TeleControl did not work properly on GO-H systems if more than two heads were connected. The bug was fixed.
- In “blinking mode” the choice of photometer head was ignored in case stabilization was skipped. Bug fixed.
- CCT positioning now serves as well the new asymmetric table designs with short extension to the front. Additionally, moving all axes is avoided in case only one axis has been altered via the CCT hardware menu.